



## CASTAÑEDA: parque / playground / parc / parque



EN 1176.







### PM523:

Madera y madera laminada tratada en autoclave clase IV, polietileno, acero pintado al polvo, acero inoxidable y cuerda de poliéster multifilamentos.

Autoclave treated class IV wood and laminated wood, polyethylene, powder coated steel, stainless steel and multifilament polyester rope.

Bois et bois lamellé-collé traité en autoclave classe IV, polyéthylène, acier peinté à la poudre, acier inoxydable et corde en polyester multifilament.

Madeira e madeira laminada tratada em autoclave classe IV, polietileno, aço pintado a pó, aço inoxidável e corda de poliéster multifilamentos.

-  3-12
-  1,64 m.
-  123 Kg.
-  1 x 1 x 3,74 m.
-  7,36 x 5,92 m.
-  31,7 m<sup>2</sup>.

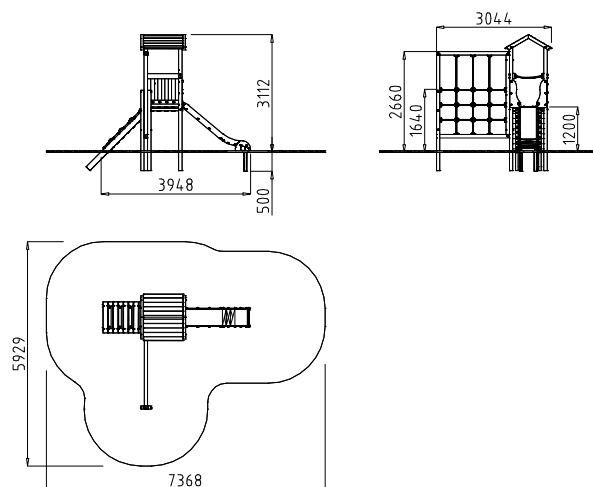

E: 1/200